

The quadratic equation in the plane

A file of the [Geometrikon](#) gallery by [Paris Pamfilos](#)

Geometrical and Mechanical phenomena are the most general, the most simple, the most abstract of all, the most irreducible to others, the most independent of them; serving, in fact, as a basis to all others. It follows that the study of them is an indispensable preliminary to that of all others. Therefore must Mathematics hold the first place in the hierarchy of the sciences, and be the point of departure of all Education, whether general or special.

A. Comte, The Positive Philosophy, Ch. II, p.33

Contents

(Last update: 09-03-2024)

1	Introduction	2
2	The allowed coordinate systems	3
3	The transformation of the coefficients	3
4	The invariants	4
5	Product of lines ($J_3 = 0$)	5
6	$J_3 = 0$: Degenerate conics	6
7	$J_3 \neq 0$: proper conics	7
8	Central conics	8
9	Find the center	8
10	Find the center, examples	9
11	Axes of central conics	10
12	Finding the normal form	11
13	Example calculation of the normal form	12
14	Finding the axes of the conic	13
15	Finding the kind of the conic	14
16	Asymptotes	14
17	The angle of the asymptotes	15

18	Rectangular hyperbola	16
19	Asymptotes directly	16
20	Parabolas	17
21	Parabola Examples	19
22	Matrix representation, tangents and secants	20
23	Conjugate directions	23
24	Polar and pol	25
25	Quadratic equation classification	26
26	Can you easily find a point on the conic?	26
27	On the focal points	29

1 Introduction

A quadratic equation in two variables (in the plane) has the form

$$f(x, y) = Ax^2 + 2Bxy + Cy^2 + 2Dx + 2Ey + F = 0. \quad (1)$$

It represents a curve in the plane referred to a coordinate system (x, y) , which in the sequel we assume to be an **orthonormal coordinate system**. The curve itself and its geometric properties is the object of the main interest. It is the building, whereas the specific coordinate system, in which the curve is described by the above equation, is the scaffold used to make the work on the building. Changing the scaffold may influence the appearance of the equation and make it simpler or more complicated. This depends on the scaffold and how well it adapts to the geometric object. The curves though, which are represented by such equations existed also before the invention of this kind of description. They are called **conic sections** or simply **conics**. They are intersections with planes of cones or cylinders. In some cases, depending on the position of the plane, we get as intersections, points and lines. These are called **degenerate conics**. All others are called **proper conics**.

2 The allowed coordinate systems

There are infinite many possible coordinate systems in which the same geometric object can be described. The acceptable coordinate systems are determined one from the other through three constants: A point $O'(x_0, y_0)$ and an angle $\frac{\pi}{4} < \phi \leq \frac{\pi}{4}$ (see figure 1). The

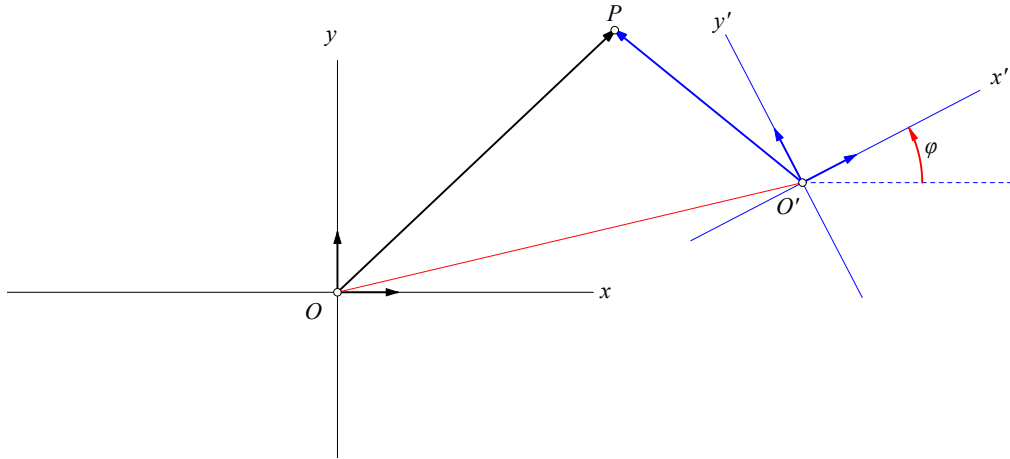

Figure 1: (x', y') system determined through $O'(x_0, y_0)$ and ϕ

same point P has coordinates with respect to the two systems: (x, y) and (x', y') . These are related through the **coordinate change** equations:

$$\left. \begin{aligned} x &= x_0 + c \cdot x' - s \cdot y', \\ y &= y_0 + s \cdot x' + c \cdot y'. \end{aligned} \right\} \Leftrightarrow \begin{cases} x' = c \cdot (x - x_0) + s \cdot (y - y_0), \\ y' = -s \cdot (x - x_0) + c \cdot (y - y_0). \end{cases} \quad (2)$$

Here $c = \cos(\phi)$, $s = \sin(\phi)$. Though there are infinite many other coordinate systems, we restrict to those that are **orthonormal** and change according to the previous relations.

3 The transformation of the coefficients

The same curve is represented by two similar equations in the two systems of coordinates:

$$\begin{aligned} Ax^2 + 2Bxy + Cy^2 + 2Dx + 2Ey + F &= 0, \\ A'x'^2 + 2B'x'y' + C'y'^2 + 2D'x' + 2E'y' + F' &= 0. \end{aligned}$$

The coefficients of the second equation result by replacing (x, y) through the formulas of the preceding section i.e. making the substitution

$$\begin{aligned} A(x_0 + cx' - sy')^2 + 2B(x_0 + cx' - sy')(y_0 + sx' + cy') + C(y_0 + sx' + cy')^2 \\ + 2D(x_0 + cx' - sy') + 2E(y_0 + sx' + cy') + F = 0 \end{aligned}$$

and writing the resulting equation in the (x', y') system:

$$A'x'^2 + 2B'x'y' + C'y'^2 + 2D'x' + 2E'y' + F' = 0.$$

The relations between the coefficients are:

$$\begin{aligned}
 A' &= Ac^2 + 2Bcs + Cs^2, \\
 B' &= (C - A)cs + B(c^2 - s^2), \\
 C' &= As^2 - 2Bcs + Cc^2, \\
 D' &= c(Ax_0 + By_0 + D) + s(Bx_0 + Cy_0 + E), \\
 E' &= -s(Ax_0 + By_0 + D) + c(Bx_0 + Cy_0 + E), \\
 F' &= f(x_0, y_0) = Ax_0^2 + 2Bx_0y_0 + Cy_0^2 + 2Dx_0 + 2Ey_0 + F.
 \end{aligned}$$

These equations imply, among other things, also the following simple consequences:

- 1) If the transformation is a pure **translation** i.e. $c=1, s=0$ (the angle $\phi = 0$), then the coefficients of the quadratic terms *do not change* i.e. $A' = A, B' = B, C' = C$.
- 2) If the transformation is a pure **rotation** i.e. $x_0 = y_0 = 0$, then the constant term *does not change* i.e. $F' = F$.

We should notice here a special case concerning the quantities $\{A - C, B\}$. If they vanish in one coordinate system, then they vanish also in every other. This, because of the preceding equations which imply:

$$\begin{aligned}
 A' - C' &= (A - C)(c^2 - s^2) + 4Bcs, \\
 B' &= (C - A)cs + B(c^2 - s^2).
 \end{aligned}$$

Also, if $\{A - C = B = 0\}$ then, assuming $A \neq 0$, the equation takes the form

$$\begin{aligned}
 x^2 + y^2 + 2(D/A)x + 2(E/A)y + (F/A) &= 0 \quad \Leftrightarrow \\
 (x + (D/A))^2 + (y + (E/A))^2 + (F/A) - (D/A)^2 - (E/A)^2 &= 0 \quad \Leftrightarrow \\
 (x - x_0)^2 + (y - y_0)^2 - R^2 &= 0,
 \end{aligned}$$

representing the **circle** with center $(x_0, y_0) = -(D/A, E/A)$ and radius which can be real or imaginary: $R^2 = (D^2 + E^2 - AF)/A^2$. This proves the theorem:

Theorem 1. *The general equation (1) represents a circle, if and only if $A - C = B = 0$, and $D^2 + E^2 - AF > 0$.*

4 The invariants

By inspecting the above transformation relations one sees easily that the expressions

$$\begin{aligned}
 J_1 &= A + C &= A' + C', \\
 J_2 &= AC - B^2 &= A'C' - B'^2, \\
 J_3 &= \begin{vmatrix} A & B & D \\ B & C & E \\ D & E & F \end{vmatrix} &= \begin{vmatrix} A' & B' & D' \\ B' & C' & E' \\ D' & E' & F' \end{vmatrix}.
 \end{aligned}$$

Thus, the three expressions, build from the coefficients of the equation with respect to a particular coordinate system, define three numbers, which are independent of the particular system used. These numbers are called **Invariants** of the quadratic equation. Their independence from the particular coordinate system suggests that their meaning is related to the geometric object, the curve, represented by the scaffold of the equation and carry important information concerning this geometric object. To prove this, we start with J_3 and then proceed to J_2 and J_1 .

5 Product of lines ($J_3 = 0$)

The simplest quadratic equations result by multiplying two line equations:

$$(ax + by + c)(a'x + b'y + c') = Ax^2 + 2Bxy + Cy^2 + 2Dx + 2Ey + F.$$

In these the coefficients are given by:

$$\begin{aligned} A &= a \cdot a', \\ B &= \frac{1}{2}(a \cdot b' + b \cdot a'), \\ C &= b \cdot b', \\ D &= \frac{1}{2}(c \cdot a' + a \cdot c'), \\ E &= \frac{1}{2}(c \cdot b' + b \cdot c'), \\ F &= c \cdot c'. \end{aligned}$$

Assume that we are in the coordinate system in which the first line ($ax + by + c = 0$) is the x-axis ($y = 0$), thus $a = 0, b = 1, c = 0$. It follows, that in this system of coordinates $A = 0, B = a'/2, C = b', D = 0, E = c'/2, F = 0$. Thus

$$J_3 = \begin{vmatrix} A & B & D \\ B & C & E \\ D & E & F \end{vmatrix} = \begin{vmatrix} 0 & a'/2 & 0 \\ a'/2 & b' & c'/2 \\ 0 & c'/2 & 0 \end{vmatrix} = 0.$$

The inverse is also true but somewhat more difficult to prove. In fact we have proved half of the following valid theorem:

Theorem 2. *The quadratic expression $Ax^2 + 2Bxy + Cy^2 + 2Dx + 2Ey + F$ decomposes to a product of linear factors*

$$Ax^2 + 2Bxy + Cy^2 + 2Dx + 2Ey + F = (ax + by + c)(a'x + b'y + c'),$$

if and only if the corresponding determinant $J_3 = 0$.

To prove the other half of the theorem, we assume that $J_3 = 0$ and try to factor the equation $f(x, y) = Ax^2 + 2Bxy + Cy^2 + 2Dx + 2Ey + F = 0$ into a product of two lines. The most complicated case is the one for which some of the coefficients A, C say A is different from zero. Thus, leaving the easiest cases for the end, we assume $A \neq 0$ and have:

$$\begin{aligned} 0 &= A \cdot f(x, y) = A^2x^2 + 2ABxy + ACy^2 + 2ADx + 2AEy + AF && \Leftrightarrow \\ A^2x^2 + 2A(By + D)x &= -ACy^2 - 2AEy - AF && \Leftrightarrow \\ (Ax + (By + D))^2 &= (By + D)^2 - ACy^2 - 2AEy - AF && \Leftrightarrow \\ (Ax + (By + D))^2 &= (B^2 - AC)y^2 + 2(BD - AE)y + D^2 - AF. \end{aligned}$$

On the right side of the last equation stands a quadratic function in y :

$$g(y) = (B^2 - AC)y^2 + 2(BD - AE)y + D^2 - AF = Uy^2 + 2Vy + W.$$

Putting also

$$h(x, y) = Ax + (By + D),$$

we obtain the relation

$$af(x, y) = h(x, y)^2 - g(y) \Leftrightarrow af(x, y) = [h(x, y) - \sqrt{g(y)}] \cdot [h(x, y) + \sqrt{g(y)}].$$

In order for this to factor into two linear terms, $g(y)$ has to be a complete square i.e. its discriminant must vanish:

$$0 = UW - V^2 = (B^2 - AC)(D^2 - AF) - (BD - AE)^2 \Leftrightarrow A \cdot J_3 = 0.$$

In the case $A = 0$ but $B \neq 0$ we do the previous work but using this time y instead of x . In the case $A = C = 0$, we see that

$$0 = J_3 = \begin{vmatrix} 0 & B & D \\ B & 0 & E \\ D & E & F \end{vmatrix} = B \cdot (2ED - BF).$$

In this case, if also $B = 0$, then all quadratic terms vanish and the curve is a line. If $B \neq 0$, then $2ED - BF = 0$ must be valid i.e. there is a constant k such that $2E = kB, F = kD$. This implies again that the equation decomposes to a product of lines:

$$0 = 2Bxy + 2Dx + 2Ey + F = 2x(By + D) + (2Ey + F) = (2x + k)(By + D).$$

6 $J_3 = 0$: Degenerate conics

A quadratic function which decomposes to two linear factors represents a degenerate conic. A (double) line:

$$f(x, y) = (ax + by + c)^2 = a^2x^2 + 2abxy + b^2y^2 + 2acx + 2acy + c^2 = 0,$$

or a pair of lines:

$$\begin{aligned} f(x, y) &= (ax + by + c)(a'x + b'y + c') \\ &= (aa')x^2 + (ab' + ba')xy + (bb')y^2 + (ac' + ca')x + (bc' + cb')y + (cc') = 0, \end{aligned}$$

or a point

$$(x - a)^2 + (y - b)^2 = 0.$$

Last equation is satisfied only by the point with coordinates (a, b) . Using complex numbers the last equation can be written:

$$(x - a)^2 + (y - b)^2 = [(x - a) + i(y - b)][(x - a) - i(y - b)] = 0.$$

Thus, in this case the quadratic equation decomposes to two linear factors too:

$$x + iy - (a + ib) = 0 \quad \text{and} \quad x - iy - (a - ib) = 0.$$

The lines, though, are complex.

The following example equation represents two intersecting lines:

$$f(x, y) = x^2 + 3xy + 2y^2 + 5x + 6y + 4 = 0.$$

One sees easily that for this equation $J_3 = 0$. To decompose into factors, order it in powers of x and complete the square:

$$\begin{aligned} f(x, y) &= x^2 + (3y + 5)x + (2y^2 + 6y + 4) \\ &= \left(x + \frac{3y + 5}{2}\right)^2 - \left(\frac{3y + 5}{2}\right)^2 + (2y^2 + 6y + 4) \\ &= \left(x + \frac{3y + 5}{2}\right)^2 - \left(\frac{y + 3}{2}\right)^2 \\ &= (x + y + 1)(x + 2y + 4). \end{aligned}$$

Exercise 1. Show that $x^2 - xy - y^2 + 2x + 1 = 0$ decomposes in a product of two intersecting lines. Determine these lines.

7 $J_3 \neq 0$: proper conics

If the quadratic equation

$$f(x, y) = Ax^2 + 2Bxy + Cy^2 + 2Dx + 2Ey + F = 0$$

has its invariant

$$J_3 = \begin{vmatrix} A & B & D \\ B & C & E \\ D & E & F \end{vmatrix} \neq 0,$$

then the corresponding curve, represented by this equation, is a **proper conic** i.e. either an ellipse or a hyperbola or a parabola (see figure 2). The ellipse and the hyperbola are

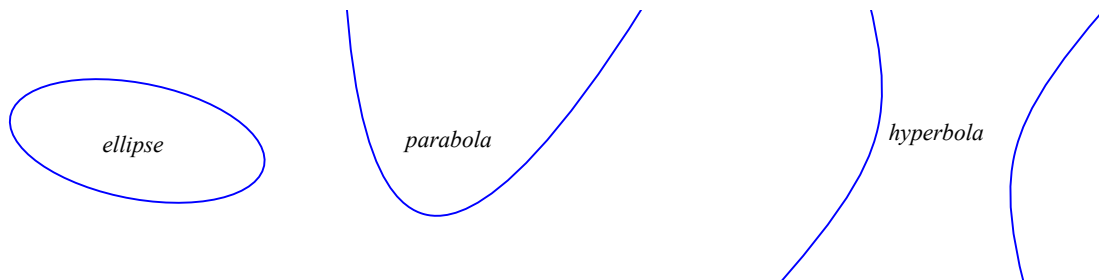

Figure 2: Proper conics

point-symmetric. There exists a point P_0 such that for every point P on the conic, line PP_0 meets the conic in a second point P' such that $|PP_0| = |P'P_0|$ (see figure 3). This point

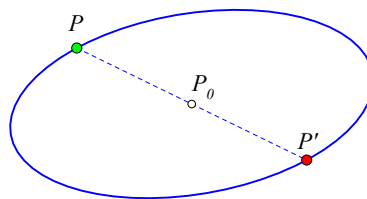

Figure 3: Ellipse's center of symmetry

is called the **center** of the conic. Ellipses and hyperbolas are called collectively **central conics**. The parabola has no center of symmetry. It has though an **axis** of symmetry. This

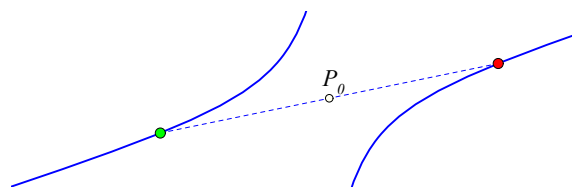

Figure 4: Hyperbola's center of symmetry

is called the **axis of the parabola** and is a line ε with the following property: for every point P on the parabola, point P' which is the **reflected** of P on the axis ε is also a point of the parabola (see figure 5).

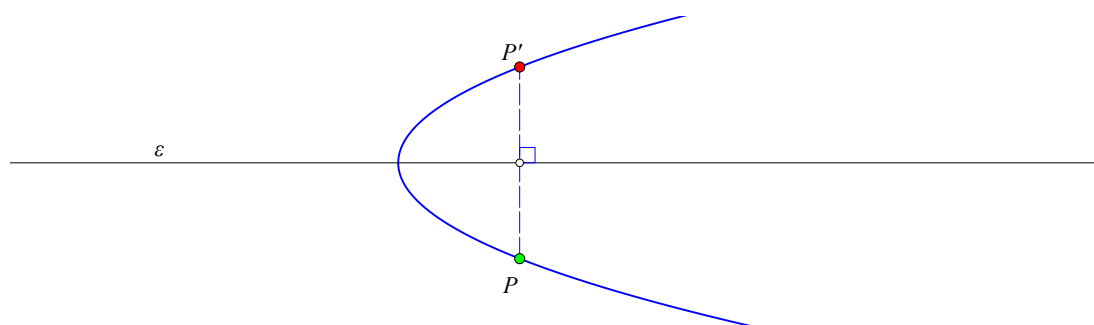

Figure 5: Parabola's axis

8 Central conics

The quadratic equation $f(x, y) = Ax^2 + 2Bxy + Cy^2 + 2Dx + 2Ey + F = 0$, which describes a **central** conic, in addition to the condition $J_3 \neq 0$, is characterized by the fact that

$$J_2 = AC - B^2 \neq 0.$$

In fact, if the conic has a symmetry center and we take a coordinate system with origin at this point, then for every point $P(x, y)$ satisfying the equation the point $P'(-x, -y)$ satisfies the equation too. Thus we have:

$$\begin{aligned} f(x, y) &= Ax^2 + 2Bxy + Cy^2 + 2Dx + 2Ey + F = 0 \Rightarrow \\ f(-x, -y) &= Ax^2 + 2Bxy + Cy^2 - 2Dx - 2Ey + F = 0 \Rightarrow \\ f(x, y) - f(-x, -y) &= 4Dx + 4Ey = 0. \end{aligned}$$

Last equation must be true for the infinite many points $P(x, y)$ of the curve. Thus implying:

$$D = E = 0.$$

Thus, for these particular coordinate systems, which are centered at the symmetry center of the conic, the linear terms are missing and its equation obtains the simpler form:

$$f(x, y) = Ax^2 + 2Bxy + Cy^2 + F = 0.$$

It follows that in this case

$$J_3 = J_2 \cdot F \neq 0,$$

which implies that $J_2 \neq 0$.

9 Find the center

To show the inverse of the previous result, we have to prove that if both $J_3 \neq 0$ and $J_2 \neq 0$ are valid then the conic can be reduced to the above simpler form. This implies that $f(x, y) = 0 \Rightarrow f(-x, -y) = 0$ and shows that the origin of the coordinate system is the center of the conic. The problem here is to start with an equation in an arbitrary system

$$f(x, y) = Ax^2 + 2Bxy + Cy^2 + 2Dx + 2Ey + F = 0,$$

and find a new coordinate system centered at the center $P_0(x_0, y_0)$ of the conic. In this new system of coordinates (x', y') the quadratic equation will have the form

$$f'(x', y') = A'x'^2 + 2B'x'y' + C'y'^2 + F' = 0.$$

Hence, by the results of section 3, the following system of equations must hold:

$$\left. \begin{aligned} D' &= (Ax_0 + By_0 + D)c + (Bx_0 + Cy_0 + E)s = 0, \\ E' &= -(Ax_0 + By_0 + D)s + (Bx_0 + Cy_0 + E)c = 0. \end{aligned} \right\} \Leftrightarrow \begin{cases} Ax_0 + By_0 + D = 0, \\ Bx_0 + Cy_0 + E = 0. \end{cases}$$

By assumption $J_2 = \begin{vmatrix} A & B \\ B & C \end{vmatrix} \neq 0$, hence the last system has a unique solution:

$$\left. \begin{aligned} x_0 &= -\frac{\begin{vmatrix} D & B \\ E & C \end{vmatrix}}{\begin{vmatrix} A & B \\ B & C \end{vmatrix}} = \frac{BE - DC}{AC - B^2}, \\ y_0 &= -\frac{\begin{vmatrix} A & D \\ B & E \end{vmatrix}}{\begin{vmatrix} A & B \\ B & C \end{vmatrix}} = \frac{DB - AE}{AC - B^2}. \end{aligned} \right\} \quad (3)$$

These equations determine the location of the center $P_0(x_0, y_0)$ of the conic with respect to the original system (x, y) of coordinates. To find the new coordinates one has to make a simple translation:

$$\begin{aligned} x &= x_0 + x', \\ y &= y_0 + y'. \end{aligned}$$

By section 3, since in this case the transformation has $c = 1, s = 0$, the coefficients of the quadratic terms are preserved and the form of the equation is

$$Ax'^2 + 2Bx'y' + Cy'^2 + F' = 0,$$

where

$$F' = f(x_0, y_0) = f\left(-\frac{DC - BE}{AC - B^2}, -\frac{AE - DB}{AC - B^2}\right) = \frac{J_3}{J_2}. \quad (4)$$

Last equation results by an easy calculation.

10 Find the center, examples

To find the proper conics $f(x, y) = 0$, which are central and have coefficients A, B, C, \dots equal to ± 1 . Locate also their centers.

$$f(x, y) = \pm x^2 \pm 2xy \pm y^2 \pm 2x \pm 2y \pm 1 = 0.$$

Originally one thinks there are 64 such examples. But there are indeed only 8. In fact $AC - B^2 \neq 0$ means in this case $AC \neq 1$, hence A, C must have different signs. Dividing the equation by A the problem reduces to the one with coefficients

$$x^2 \pm 2xy - y^2 \pm 2x \pm 2y \pm 1 = 0.$$

Thus there are only 16 to test, and from these only 8 have $J_3 \neq 0$. These are:

- (1) $x^2 + 2xy - y^2 + 2x + 2y - 1 = 0$, center: $(-1, 0)$,
- (2) $x^2 + 2xy - y^2 + 2x - 2y + 1 = 0$, center: $(0, -1)$,
- (3) $x^2 + 2xy - y^2 - 2x + 2y + 1 = 0$, center: $(0, 1)$,
- (4) $x^2 + 2xy - y^2 - 2x - 2y - 1 = 0$, center: $(1, 0)$,

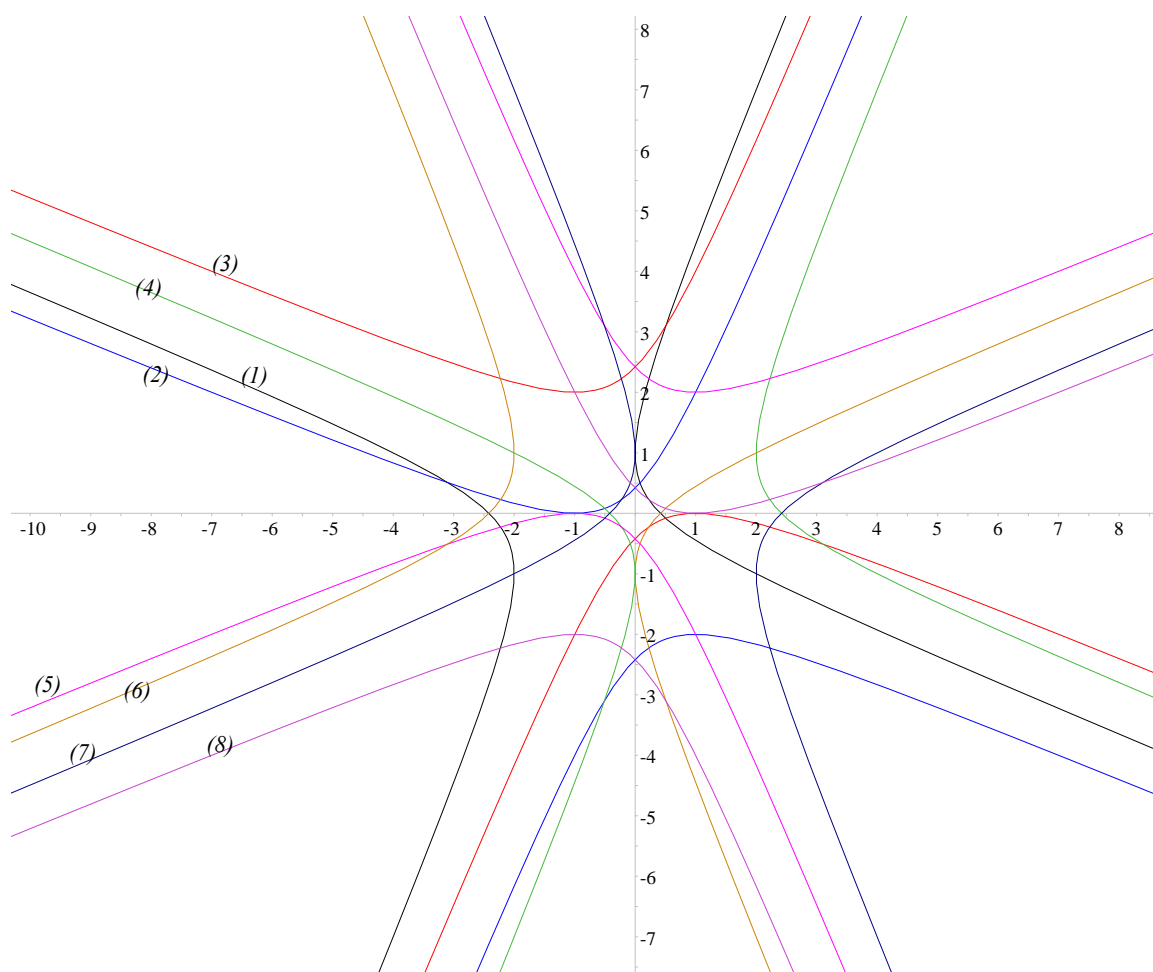

Figure 6: 8 congruent rectangular hyperbolas

$$\begin{aligned}
 (5) \quad & x^2 - 2xy - y^2 + 2x + 2y + 1 = 0, & \text{center:} & \quad (0, 1), \\
 (6) \quad & x^2 - 2xy - y^2 + 2x - 2y - 1 = 0, & \text{center:} & \quad (-1, 0), \\
 (7) \quad & x^2 - 2xy - y^2 - 2x + 2y - 1 = 0, & \text{center:} & \quad (1, 0), \\
 (8) \quad & x^2 - 2xy - y^2 - 2x - 2y + 1 = 0, & \text{center:} & \quad (0, -1).
 \end{aligned}$$

Figure 6 shows these 8 conics. They are all hyperbolas, even **rectangular** (we'll see what this means in a moment) and they are all **congruent** to each-other i.e. they can be set one upon the other, so that they coincide, or equivalently "*they have the same normal form*" (see section 12). In this context two normal forms are considered the same also if one of the forms results from the other by interchanging the role of x and y .

11 Axes of central conics

Central conics have also **two** axes of symmetry which are orthogonal to each other and pass through their center. Obviously it would simplify the equation if we could change to a coordinate system that has these axes as coordinate axes. In section 8 we saw that central conics referred to a coordinate system with origin identical with their center have a simplified corresponding equation:

$$f(x, y) = Ax^2 + 2Bxy + Cy^2 + F = 0.$$

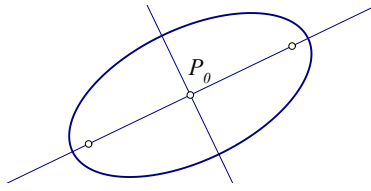

Figure 7: Ellipse with its center and its axes

If we assume also that the axes coincide with the symmetry axes of the curve, then with

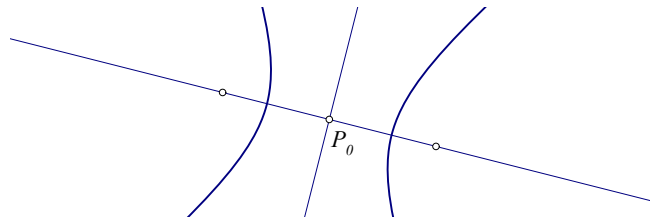

Figure 8: Hyperbola with its center and its axes

each $P(x, y)$ on the curve, points $P'(-x, y), P''(x, -y)$ must also be on the curve, so that equations

$$f(-x, y) = f(x, -y) = Ax^2 - 2Bxy + Cy^2 + F = 0,$$

must also be valid. By subtracting the two equations we see that in such a system the mixed xy -coefficient must be zero:

$$B = 0.$$

Then the quadratic equation reduces to a simpler form:

$$Ax^2 + Cy^2 + F = 0.$$

Notice the difference from the equation in section 1. Here the equation is much simpler, the coordinates though are not the original any more. One should write the equation using something like (x', y') but I dropped the primes for aesthetic reasons. It is usual to make coordinate changes from (x, y) to (x', y') , then, possibly to others (x'', y'') and still others ... but at the final stage use the simple symbols (x, y) , knowing that they are different from the original ones. The last equation is referred as the **normal form** of the equation of the conic.

12 Finding the normal form

The problem of finding the normal form of a proper central conic can be solved easily using the invariants. In fact let us now distinguish the various coordinate systems. In the first system, which is assumed to be an arbitrary one, the equation has the form:

$$f(x, y) = Ax^2 + 2Bxy + Cy^2 + 2Dx + 2Ey + F = 0.$$

If we translate to the symmetry center (x_0, y_0) , then the equation becomes

$$f'(x', y') = Ax'^2 + 2Bx'y' + Cy'^2 + F' = 0, \quad \text{with } F' = f(x_0, y_0) = \frac{J_3}{J_2}.$$

If now, holding the origin fixed, we turn the axes so that the new axes coincide with the axes of the conic, then the equation in the new coordinates obtains the form

$$f''(x'', y'') = A'x''^2 + C'y''^2 + F' = 0.$$

Since F' is already known, it remains to find the values of A', C' . But these constants satisfy

$$A' + C' = A + C = J_1, \quad \text{and} \quad A' \cdot C' = AC - B^2 = J_2.$$

Thus, their sum and product are obtainable from the original equation and the two constants are the roots of the equation involving once again the ubiquitous invariants:

$$x^2 - J_1x + J_2 = 0. \quad (5)$$

Even which of $\{A', C'\}$ is bigger can be seen from the original equation. In fact, if $s = \sin(\phi)$, $c = \cos(\phi)$, where ϕ is the angle by which we turn the original axes to the final axes of the conic, then, by the relations of section 3, the two coefficients are related by the equation

$$A' - C' = (c^2 - s^2)(A - C) + 4Bcs.$$

But the vanishing of B' for this coordinate change implies

$$0 = B' = (C - A)cs + B(c^2 - s^2).$$

If neither B nor $C - A$ vanish, then solving the last for B and replacing in the previous equation gives:

$$A' - C' = (A - C) \left(c^2 - s^2 + 4 \frac{c^2 s^2}{c^2 - s^2} \right).$$

By the conventions made in section 2, angle ϕ satisfies $-\frac{\pi}{4} < \phi \leq \frac{\pi}{4}$, and $c^2 - s^2 = \cos(2\phi) > 0$ under this restriction, i.e. $(A - C)$ and $(A' - C')$ have the same sign. Thus, which one from A', C' is greater from the other can be seen directly from the original equation.

In the case $B = 0$ the axes are already the symmetry axes of the conic. In the case $A - C = 0$, taking $\phi = \frac{\pi}{4}$ implies $B' = 0$, which means that the axes are the bisectors of the present orthogonal system of coordinates.

13 Example calculation of the normal form

To see the previous procedure working, let us apply it to the example of section 10

$$x^2 + 2xy - y^2 + 2x + 2y - 1 = 0.$$

Here we see easily that $J_1 = 0, J_2 = -2, J_3 = 4$. Thus,

$$F' = \frac{J_3}{J_2} = -2,$$

and A', C' are the roots of the equation

$$x^2 - 2 = 0 \quad \Rightarrow \quad A' = \sqrt{2}, C' = -\sqrt{2}.$$

In the last decision, which of the roots to equal to A' and which to C' , we take into account that $A' - C'$ and $A - C = 2$ must have equal signs. Thus the normal form (dropping again the primes) is

$$f_1(x, y) = \sqrt{2}x^2 - \sqrt{2}y^2 - 2 = 0.$$

Let us repeat the procedure for the second equation in section 10

$$x^2 + 2xy - y^2 + 2x - 2y + 1 = 0, \quad \text{with} \quad J_1 = 0, J_2 = -2, J_3 = -4.$$

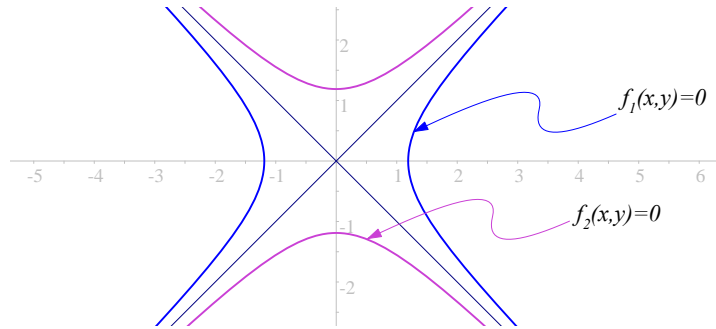

Figure 9: Conjugate rectangular hyperbolas

Thus, A', C' satisfy the equation $x^2 - 2 = 0$ and we have again

$$F' = \frac{J_3}{J_2} = 2, A' = \sqrt{2}, B' = -\sqrt{2} \Rightarrow f_2(x, y) = \sqrt{2}x^2 - \sqrt{2}y^2 + 2 = 0.$$

By interchanging the roles of x and y we see that the curves corresponding to these equations are **congruent**. Figure 9 shows the two congruent conics, which are “conjugate rectangular hyperbolas” resulting, each from the other through a rotation about the origin of the axes by 90° .

14 Finding the axes of the conic

As noticed in section 11, the directions of the symmetry axes of a proper central conic can be determined by the condition $B' = 0$ which must be valid, when the conic is referred to its normal coordinate system with origin at its center. From section 3, leaving some special cases aside, this implies

$$0 = B' = (C - A)cs + B(c^2 - s^2) \Rightarrow \frac{2cs}{c^2 - s^2} = \frac{2B}{A - C}.$$

Since

$$\frac{2cs}{c^2 - s^2} = \frac{2 \cos(\phi) \sin(\phi)}{\cos(\phi)^2 - \sin(\phi)^2} = \frac{\sin(2\phi)}{\cos(2\phi)} = \tan(2\phi),$$

the above equation becomes

$$\tan(2\phi) = \frac{2B}{A - C}.$$

This defines the angle ϕ by which the actual axes have to be rotated in order to obtain the right directions of the conic axes. The special cases left are $B = 0$ i.e. the current coordinate system is already the right one, and $A - C = 0$, in which taking $\phi = \frac{\pi}{4}$ makes $B' = 0$.

For example the first of the equations in section 10:

$$x^2 + 2xy - y^2 + 2x + 2y - 1 = 0,$$

has $B = 1, A - C = 2$, hence $\tan(2\phi) = 1 \Rightarrow 2\phi = \frac{\pi}{4} \Rightarrow \phi = \frac{\pi}{8}$.

15 Finding the kind of the conic

The hyperbola is unbounded and the ellipse is bounded. This is the fundamental distinction of the two kinds of *proper central* conics. The kind of the conic can be immediately deduced from the normal form:

$$Ax^2 + Cy^2 + F = 0.$$

If all coefficients are positive then no real conic exists. If A, C have the same sign, which is equivalent with the condition that $J_2 > 0$, then we have an ellipse in the case $F \cdot J_2 = J_3 < 0$ and no real curve if $J_3 > 0$. In fact, in this case, multiplying the whole equation by -1 if necessary, we may assume that $A, C > 0$ and $F < 0$ and the equation becomes

$$(-F) = Ax^2 + Cy^2 \geq m(x^2 + y^2) \Rightarrow x^2 + y^2 \leq \frac{-F}{m}.$$

where m is the smaller of A, C . This shows that all points of the curve are at square-distance from the origin less than $\frac{-F}{m}$, hence the curve is bounded i.e. it is an ellipse.

If A, C have different signs, which is equivalent with $J_2 < 0$, then we have always a hyperbola. In fact, in this case, we can assume that one coefficient, A say, is positive and $\{C, F\}$ are negative and set the equation in the form

$$Ax^2 + Cy^2 + F = 0 \Rightarrow x^2 = \frac{1}{A}(-Cy^2 - F),$$

which shows that (x, y) can obtain arbitrary big values, hence the curve is unbounded i.e. it is a hyperbola. If $C > 0$ and $\{A, F\}$ negative we solve w.r.t. y^2 and work analogously.

16 Asymptotes

The simplest way to define the **asymptotes** of a proper central conic is to use its normal form

$$Ax^2 + Cy^2 + F = 0. \tag{6}$$

The lines resulting from the equation

$$Ax^2 + Cy^2 = 0,$$

are called the asymptotes of the conic. They are two real lines only in the case of hyperbolas, i.e. when $J_2 < 0$. In this case, assuming $A > 0$ and $C < 0$, the quadratic equation decomposes to a product :

$$Ax^2 + Cy^2 = (\sqrt{A}x - \sqrt{-C}y)(\sqrt{A}x + \sqrt{-C}y) = 0.$$

The figure shows the hyperbola

$$2x^2 - y^2 - 1 = 0,$$

and its asymptotes, which are the lines

$$\sqrt{2}x - y = 0, \text{ and } \sqrt{2}x + y = 0.$$

Since the equation of the hyperbola and the equation of its asymptotic lines in the coordinate system of the normal form differ by a constant, going back to the original coordinates

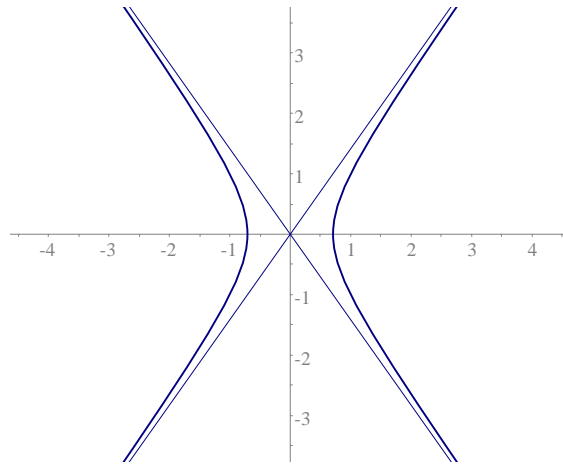

Figure 10: Hyperbola and its asymptotes

system the corresponding equations will differ also by a constant. Thus, the equation of the asymptotic lines in the original coordinate system of the equation of the conic

$$f(x, y) = Ax^2 + 2Bxy + Cy^2 + 2Dx + 2Ey + F = 0,$$

must be of the form

$$f'(x, y) = Ax^2 + 2Bxy + Cy^2 + 2Dx + 2Ey + F + k = 0, \quad \text{for some constant } k.$$

Thus, by section 5, the coefficients of this quadratic must satisfy the relation

$$J'_3 = \begin{vmatrix} A & B & D \\ B & C & E \\ D & E & F + k \end{vmatrix} = J_3 + kJ_2 = 0 \quad \Rightarrow \quad k = -\frac{J_3}{J_2}.$$

Thus the equation of the asymptotes in the original coordinate system is

$$f(x, y) = Ax^2 + 2Bxy + Cy^2 + 2Dx + 2Ey + \left(F - \frac{J_3}{J_2}\right) = 0.$$

17 The angle of the asymptotes

The cosine of the angle of the asymptotes is calculated by the inner product of the unit vectors in the direction of the lines. By the preceding section, using equation (6) and assuming $\{A > 0, C < 0\}$, these vectors are

$$\frac{1}{\sqrt{A-C}}(\sqrt{-C}, \sqrt{A}), \quad \text{and} \quad \frac{1}{\sqrt{A-C}}(-\sqrt{-C}, \sqrt{A}).$$

And their inner product giving the cosine ($\cos(\theta)$) of the angle between the asymptotes is

$$\begin{aligned}\cos(\theta) &= \frac{1}{\sqrt{A-C}}(\sqrt{-C}, \sqrt{A}) \cdot \frac{1}{\sqrt{A-C}}(-\sqrt{-C}, \sqrt{A}) \\ &= \frac{A+C}{A-C} \\ &= \frac{A+C}{\sqrt{(A-C)^2}} \\ &= \frac{A+C}{\sqrt{(A+C)^2 - 4AC}} \\ &= \frac{A+C}{\sqrt{(A+C)^2 - 4(AC - B^2)}} \quad (\text{since } B = 0), \\ &= \frac{J_1}{\sqrt{J_1^2 - 4J_2}}.\end{aligned}$$

18 Rectangular hyperbola

This kind of proper conic is characterized by the condition

$$J_1 = A + C = 0.$$

This implies

$$J_2 = AC - B^2 = -A^2 - B^2 < 0.$$

Hence, by section 15, this is a hyperbola. As already noticed, all examples of section 10 and the two examples of section 13 are rectangular hyperbolas. Rectangular hyperbolas have their asymptotes orthogonal (therefore the name). They are the only conics which appear as the graph of an “invertible” function (in its domain of definition). The most prominent example is the graph of the function $y = \frac{1}{x}$ represented by the quadratic

$$xy - 1 = 0,$$

for which the corresponding invariants are $J_1 = 0, J_2 = -\frac{1}{4}, J_3 = \frac{1}{4}$, leading to the normal form

$$A'x'^2 + C'y'^2 + F' = 0 \quad : \quad \frac{1}{2}x'^2 - \frac{1}{2}y'^2 - 1 = 0.$$

Figure 11 shows the curve and the two coordinate systems (x, y) and (x', y') .

19 Asymptotes directly

Given the quadratic equation

$$f(x, y) = Ax^2 + 2Bxy + Cy^2 + 2Dx + 2Ey + F = 0,$$

the directions of asymptotes can be directly determined by dropping the linear terms and equating the remaining expression to zero:

$$Ax^2 + 2Bxy + Cy^2 = 0.$$

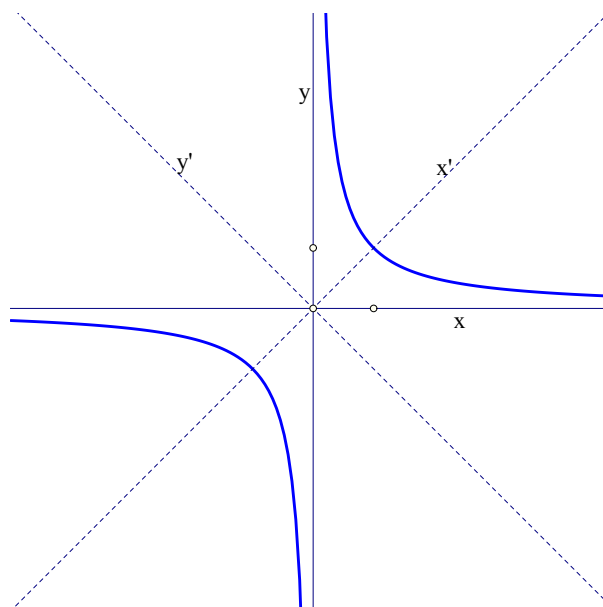

Figure 11: The graph of $y = \frac{1}{x}$ is a rectangular hyperbola

In fact, as noticed in section 3, the quadratic coefficients A, B, C do not change if we change to the coordinate system at the center, without to turn the axes. Turning now the axes to match the axes of the conic is done by a transformation of the form

$$\begin{cases} x = c \cdot x' - s \cdot y', \\ y = s \cdot x' + c \cdot y'. \end{cases} \Leftrightarrow \begin{cases} x' = c \cdot x + s \cdot y, \\ y' = -s \cdot x + c \cdot y. \end{cases}$$

Taking into account the relations between A, B, C and A', B', C' given in section 3, we see by an easy calculation that

$$Ax^2 + 2Bxy + Cy^2 = 0 \Leftrightarrow A'x'^2 + 2B'x'y' + Cy'^2 = 0,$$

i.e. the last equation involving the (x', y') coordinates is valid, if and only if, the left equation for the corresponding coordinates in (x, y) is valid.

A trivial example of this fact is given by the hyperbola $xy = 1$ of the previous section. In the (x, y) system the asymptotes are given by equating

$$xy = 0 \text{ i.e. either } x = 0 \text{ or } y = 0.$$

In the (x', y') system the same asymptotes are given by the equation

$$\frac{1}{2}x'^2 - \frac{1}{2}y'^2 = 0 \Leftrightarrow x' - y' = 0 \text{ or } x' + y' = 0.$$

This means that in the (x, y) system the asymptotes coincide with the coordinate axes, whereas in the (x', y') system the asymptotes coincide with the bisectors of the corresponding coordinate axes.

20 Parabolas

The parabolas are the proper “non-central” conics. They are thus characterized by the two invariants being:

$$J_3 \neq 0 \text{ and } J_2 = AC - B^2 = 0.$$

The expression $-J_2 = B^2 - AC$ is seen to be the discriminant of the polynomial $At^2 + 2Bt + C$. Thus its vanishing means that the polynomial has a double root $t = -\frac{B}{A}$. The coefficients $\{A, C\}$ must be non-zero, since in the contrary case $B^2 - AC = 0$ would imply $B = 0$ and consequently also $J_3 = 0$, which has been excluded. In this case the equation can be written

$$At^2 + 2Bt + C = A \left(t + \frac{B}{A} \right)^2.$$

This, setting $t = \frac{x}{y}$, implies

$$Ax^2 + 2Bxy + Cy^2 = y^2(At^2 + 2Bt + C) = y^2A \left(\frac{x}{y} + \frac{B}{A} \right)^2 = \frac{1}{A}(Ax + By)^2.$$

The original equation then can be written in the form

$$(Ax + By)^2 + 2ADx + 2AEy + AF = 0. \quad (7)$$

This suggests to make the transformation

$$\begin{cases} x = c \cdot x' - s \cdot y', \\ y = s \cdot x' + c \cdot y', \end{cases} \Leftrightarrow \begin{cases} x' = c \cdot x + s \cdot y, \\ y' = -s \cdot x + c \cdot y, \end{cases} \quad (8)$$

where

$$c = \frac{A}{\sqrt{A^2 + B^2}}, \quad s = \frac{B}{\sqrt{A^2 + B^2}}.$$

By this equation (7) transforms according to the rules of section 3 and we see that the new coefficients in the (x', y') coordinate system, taking into account that $B^2 = AC$ and dividing the resulting expressions on the right by A , are

$$\begin{aligned} A' &= (A + C) = J_1, \\ B' &= 0, \\ C' &= 0, \\ D' &= \frac{AD + EB}{\sqrt{A^2 + B^2}}, \\ E' &= \frac{-DB + EA}{\sqrt{A^2 + B^2}}, \\ F' &= F. \end{aligned}$$

Note that $J_1 = A + C \neq 0$. This follows from the fact that $0 = J_2 = AC - B^2$ implies that A, C have the same sign. Hence $A + C = 0$ would imply $A = C = B = 0$ and the conic would be non proper, which contradicts our assumption. The same reasoning shows that $A \neq 0$ and legitimates the aforementioned division.

$$\begin{aligned} J_1 x'^2 + 2D'x' + 2E'y' + F &= 0 && \Leftrightarrow \\ x'^2 + 2\frac{D'}{J_1}x' + 2\frac{E'}{J_1}y' + \frac{F}{J_1} &= 0 && \Leftrightarrow \\ x'^2 + 2D''x' + 2E''y' + F'' &= 0 && \Leftrightarrow \\ (x' + D'')^2 + 2E''y' + (F'' - D''^2) &= 0, \end{aligned}$$

with the obvious substitution $D'' = \frac{D'}{J_1}$, $E'' = \frac{E'}{J_1}$, $F'' = \frac{F}{J_1}$. Again $E'' \neq 0$, since $E'' = 0$ would imply again that the conic is non-proper. Thus, by dividing through E'' and making the translation of the coordinate system:

$$\begin{aligned}x_1 &= x' + D'', \\y_1 &= y' + \frac{F'' - D''^2}{E''},\end{aligned}$$

we obtain the equation

$$x_1^2 + 2E''y_1 = 0,$$

which is the normal form of a parabola.

Using the first form of the equation above and computing the invariant J_3 we see that $J_3 = -E'^2J_1$ (which implies that $J_3 \cdot J_1 < 0$) and since $E' = J_1E''$ we conclude that

$$E''^2 = -\frac{J_3}{J_1^3}. \quad (9)$$

Notice that the sign of E'' is not so important for the shape of the parabola, since $x^2 \pm 2Ey = 0$ represent two parabolas which are symmetric with respect to the x -axis. Also we notice that the line $x_1 = 0$ is an of symmetry of the parabola, since if (x_1, y_1) is a point of the parabola, then the same is true for the point $(-x_1, y_1)$. The line $x_1 = 0$ is the "axis" of the parabola. Making the substitutions back to the original variables (x, y) we find that equation $x_1 = 0$ is equivalent to

$$Ax + By + \frac{AD + BE}{J_1} = 0, \quad (10)$$

showing that the axis of symmetry of the parabola is parallel to the line $Ax + By = 0$ with the coefficients of the original equation (1).

21 Parabola Examples

The following cases are all possible parabolas with A, B, C, \dots having the values ± 1 .

- (1) $x^2 + 2xy + y^2 + 2x - 2y + 1 = 0$,
- (2) $x^2 + 2xy + y^2 + 2x - 2y - 1 = 0$,
- (3) $x^2 + 2xy + y^2 - 2x + 2y + 1 = 0$,
- (4) $x^2 + 2xy + y^2 - 2x + 2y - 1 = 0$,
- (5) $x^2 - 2xy + y^2 + 2x + 2y + 1 = 0$,
- (6) $x^2 - 2xy + y^2 + 2x + 2y - 1 = 0$,
- (7) $x^2 - 2xy + y^2 - 2x - 2y + 1 = 0$,
- (8) $x^2 - 2xy + y^2 - 2x - 2y - 1 = 0$,

They all have $J_1 = 2$, $J_2 = 0$ and $J_3 = -4$, so that in the normal form appearing in the previous section $E'' = \pm \frac{1}{\sqrt{2}}$ and all of them have the normal form:

$$x^2 - \sqrt{2}y = 0.$$

Thus, they are all congruent. Figure 11 displays all of them, the numbers referring to the corresponding equation of the curve.

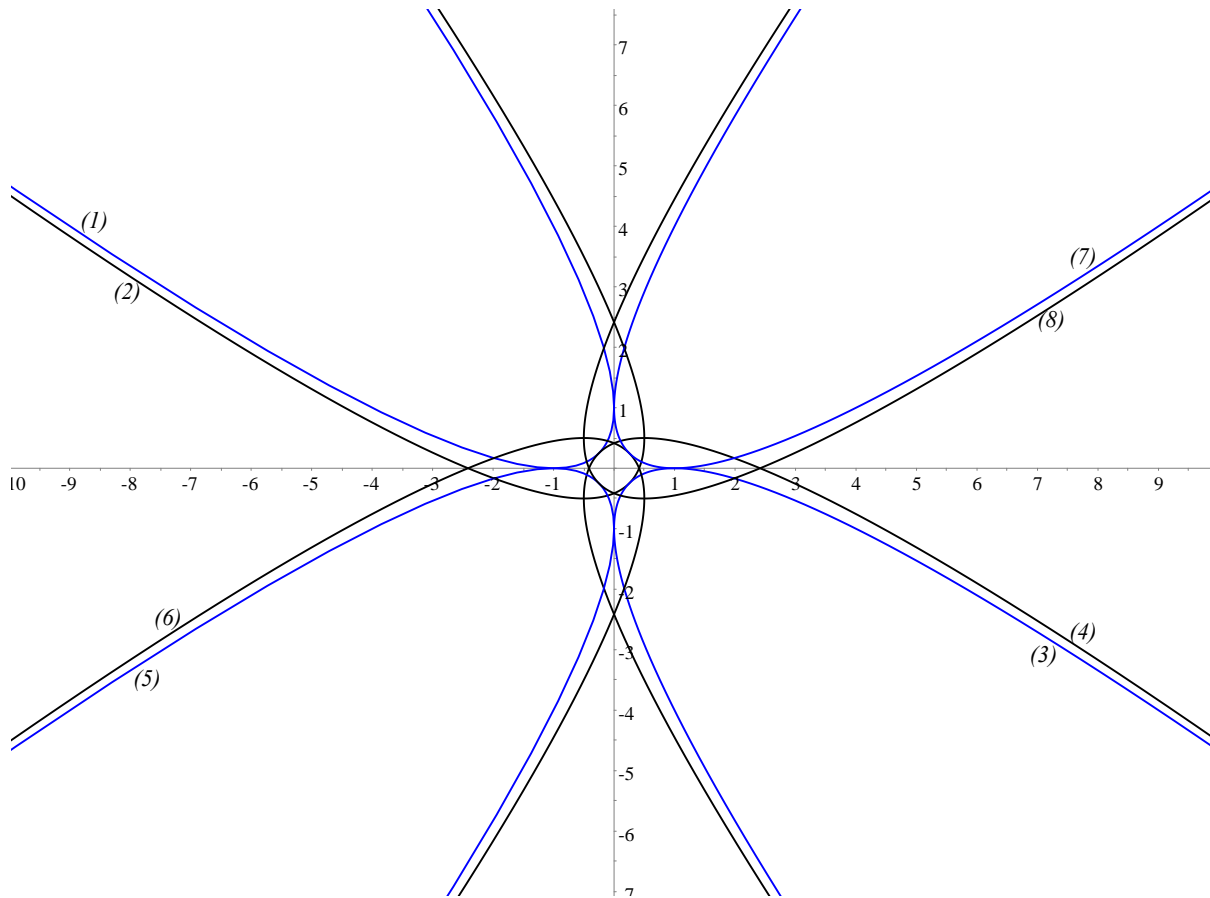

Figure 12: The eight parabolas with coefficients ± 1

22 Matrix representation, tangents and secants

Equation (1) can be written using vectors, matrix-multiplication and the symmetric matrix:

$$M = \begin{pmatrix} A & B & D \\ B & C & E \\ D & E & F \end{pmatrix} : f(x, y) = (x, y, 1) \cdot M \cdot \begin{pmatrix} x \\ y \\ 1 \end{pmatrix} = 0. \quad (11)$$

Vectors $X = \begin{pmatrix} x \\ y \\ 1 \end{pmatrix}$ represent **points**, and vectors $V = \begin{pmatrix} v_1 \\ v_2 \\ 0 \end{pmatrix}$ represent **directions**,

so that a line $\gamma(t)$ of the plane in parametric form, passing through (x_0, y_0) in direction (v_1, v_2) , is represented by

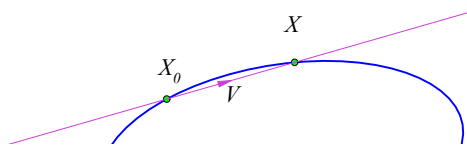

Figure 13: Line $\gamma(t) = X_0 + tV$ intersecting again in X

$$\gamma(t) = \begin{pmatrix} x_0 \\ y_0 \\ 1 \end{pmatrix} + t \cdot \begin{pmatrix} v_1 \\ v_2 \\ 0 \end{pmatrix}.$$

Assume now $\gamma(t)$ is a line passing through X_0 lying on the conic and intersecting it a second time at $X = X_0 + tV$ (see figure 13). Then both $\{X_0, X\}$ satisfy the equation (11) and, denoting by $X^t = (x, y, 1)$ the **transposed** row vector of the column vector X , we have the property:

$$\begin{aligned} 0 &= X^t M X = (X_0 + tV)^t M (X_0 + tV) \\ &= X_0^t M X_0 + 2t X_0^t M V + t^2 V^t M V \\ &= 2X_0^t M V + t V^t M V \quad \Rightarrow \quad t = -2(X_0^t M V) / (V^t M V). \end{aligned} \quad (12)$$

If X approaches X_0 then t tends to 0 and V becomes the direction of the tangent at X_0 , thus satisfying

$$X_0^t M V = 0 \quad \Leftrightarrow \quad 0 = X_0^t M (X - X_0) \quad \Leftrightarrow \quad X_0^t M X = 0, \quad (13)$$

latter being the **equation of the tangent** at X_0 . Also if X_0 is not on the conic and $X = X_0 + tV$ is indeed on the conic, we have

$$0 = X^t M X = X_0^t M X_0 + 2t X_0^t M V + t^2 V^t M V.$$

If X is a tangent point of the tangent from X_0 , then the two solutions of the quadratic must coincide and the discriminant must be zero:

$$(X_0^t M V)^2 - (X_0^t M X_0)(V^t M V) = 0.$$

This, setting for the direction vector $V = X - X_0$, where X an arbitrary point of the tangent from X_0 , implies after doing the calculation:

$$(X_0^t M X)^2 - (X_0^t M X_0)(X^t M X) = 0. \quad (14)$$

This is a quadratic **equation of the pair of tangents from** X_0 , which can be real or imaginary.

Exercise 2. Show that the equation of the two tangents to the conic $\alpha x^2 + \beta y^2 = 1$ from the point $X_0(x_0, y_0)$ can also be written in the form:

$$\alpha\beta(x y_0 - y x_0)^2 - \alpha(x - x_0)^2 - \beta(y - y_0)^2 = 0. \quad (15)$$

Theorem 3 (Newton's theorem). Consider two lines $\{\alpha, \beta\}$ parallel to the fixed unit directions $\{V, W\}$ (see figure 14) intersecting at the point P and also intersecting the conic κ at the points $\{X_1, X_2\}$ the line α and the points $\{Y_1, Y_2\}$ the line β . Then the ratio of the products

$$\frac{P X_1 \cdot P X_2}{P Y_1 \cdot P Y_2} = \frac{W^t M W}{V^t M V},$$

is independent of the location of X and depends only on the (fixed) directions $\{V, W\}$ of the lines.

In fact, assuming $\{V(v_1, v_2, 0), W(w_1, w_2, 0)\}$ to be **unit vectors** (i.e. of measure $|V| = |W| = 1$), the intersection points of the lines with the conic are respectively determined through the roots of the equations

$$\begin{aligned} \alpha &: (P + sV)^t M (P + sV) = s^2 V^t M V + 2s P^t M V + P^t M P = 0 \quad \text{and} \\ \beta &: (P + \sigma W)^t M (P + \sigma W) = \sigma^2 W^t M W + 2\sigma P^t M W + P^t M P = 0. \end{aligned}$$

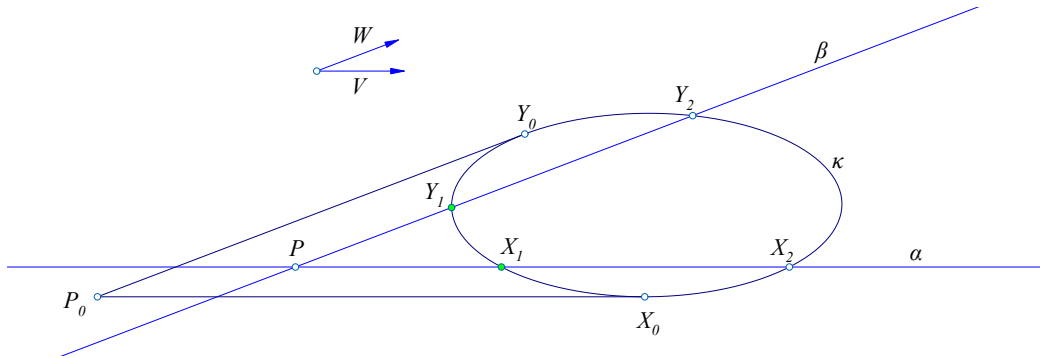

Figure 14: Newton's theorem

If $\{s_1, s_2\}$ are the roots of the first equation, and $\{\sigma_1, \sigma_2\}$ the roots of the second, then

$$\begin{aligned}
 PX_1 \cdot PX_2 &= s_1 s_2 = P^t MP / V^t MV \quad \text{and} \\
 PY_1 \cdot PY_2 &= \sigma_1 \sigma_2 = P^t MP / W^t MW \quad \Rightarrow \\
 \frac{PX_1 \cdot PX_2}{PY_1 \cdot PY_2} &= \frac{s_1 s_2}{\sigma_1 \sigma_2} = \frac{P^t MP / V^t MV}{P^t MP / W^t MW} = \frac{W^t MW}{V^t MV},
 \end{aligned}$$

which is a constant k , depending only on the unit directions $\{V, W\}$ of the lines and not on the location of the particular point P .

In the case the lines $\{\alpha, \beta\}$ approach tangents to the conic the points $\{(X_1, X_2), (Y_1, Y_2)\}$ tend to coincide with the corresponding contact points $\{X_0, Y_0\}$ and we have:

Corollary 1. *With the assumptions of the preceding theorem, if there is a point P_0 from which the tangents $\{P_0 X_0, P_0 Y_0\}$ to the conic κ are parallel to the fixed unit directions $\{V, W\}$, then the quotient of the squares of the tangents (see figure 14)*

$$\frac{(P_0 X_0)^2}{(P_0 Y_0)^2}$$

is equal to the constant $k = \frac{W^t MW}{V^t MV}$ of the theorem.

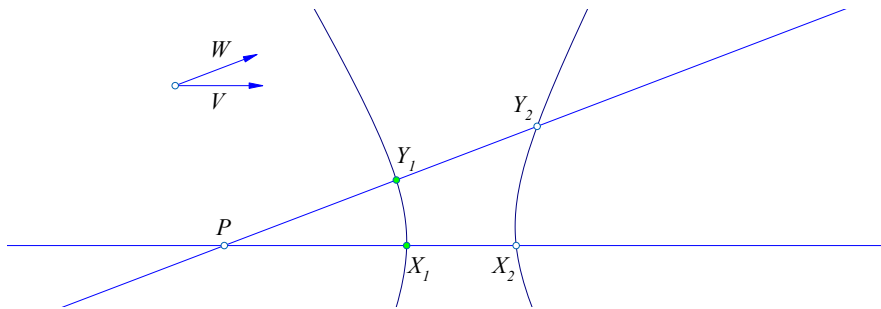

Figure 15: The case of hyperbola

Figure 15 shows that there are conics (hyperbolas) and special directions, for which a point P_0 , as needed by corollary 1, cannot exist. For the directions $\{V, W\}$ shown there is no point P_0 from which there can be drawn two tangents respectively parallel to $\{V, W\}$. For all points P of the plane, lines through P parallel to the shown directions $\{V, W\}$ are never tangent to the conic, intersecting it always at two distinct points.

Remark 1. Newton's theorem could be considered as a generalization of the "power of a point w.r.t. a circle". In the circle case the quotient is independent from the directions $\{V, W\}$ of the lines, as well as, from the point P : $\frac{PX_1 \cdot PX_2}{PY_1 \cdot PY_2} = 1$.

23 Conjugate directions

Continuing with the matrix representation of the preceding section and using the coordinates of the center $O = (x_0, y_0, 1)$ of a *central conic* expressed through equations (3), we see easily that for every *direction* $V^t = (v_1, v_2, 0)$ the product

$$O^t M V = 0 .$$

This can be interpreted by saying: *All the lines of the form $\{X^t M V = 0\}$, for a fixed direction vector V (and variable X), pass through the center of the conic.* This will be used to show a basic property of conics (see figure 16):

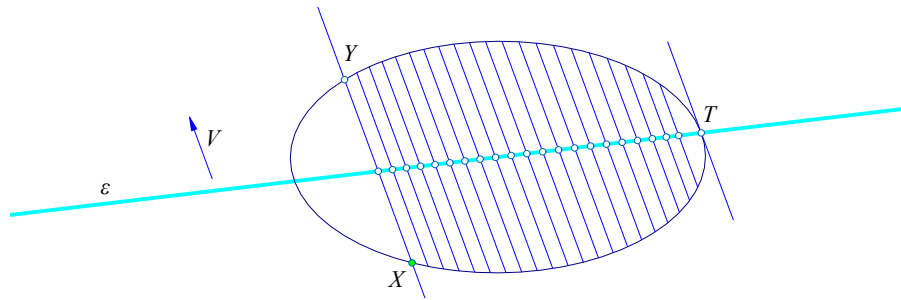

Figure 16: The line ε of the middles of parallel chords

Theorem 4. *The middles of chords XY of a conic, parallel to the direction V , lie on a line through the center of the conic, whose direction W satisfies $W^t M V = 0$. If this line intersects the conic at a point T then the tangent at T is parallel to the chords.*

In fact, consider a unit vector $V = (v_1, v_2, 0)^t$ defining a fixed direction and a variable point X on the conic. Let $Y = X + sV$ be the second intersection point of the conic with the line $\{X + tV, t \in \mathbb{R}\}$. Then, X as well Y , satisfy both the conic equation:

$$\begin{aligned} X^t M X &= Y^t M Y = 0 \quad \Rightarrow \\ (X + sV)^t M (X + sV) &= X^t M X + 2sX^t M V + s^2 V^t M V = 0 \quad \Rightarrow \\ 2X^t M V + sV^t M V &= 0 \quad \Leftrightarrow \quad \left(X + \frac{s}{2}V\right)^t M V = 0 . \end{aligned} \quad (16)$$

Since MV is a constant vector, last equation means that all points $\{Z = X + \frac{s}{2}V\}$ are on a line $\varepsilon : Z^t M V = 0$, whose coefficients are given by the coordinates of the vector MV . As we noticed at the beginning of the section, the center O of the conic is on such a line, hence the line can be represented parametrically by an equation of the form $Z = O + \sigma W$ with W a fixed direction $W^t = (w_1, w_2, 0)$. Replacing that in the last equation we find

$$0 = Z^t M V = (O + \sigma W)^t M V = O^t M V + \sigma W^t M V = \sigma W^t M V .$$

Since this holds for all σ we conclude that $W^t M V = 0$.

The claim about the tangent at T follows from the fact that such a tangent is the limit of chords XY parallel to it, whose middles are on the line ε .

Corollary 2. *If the chords parallel to the direction V have their middles on the line $O + \sigma W$ then the chords parallel to the direction W have their middles on the line with direction V .*

This follows immediately from the symmetry of the matrix M and, the resulting from this, symmetry of the relation $W^t M V = 0$, characteristic for both cases of parallel chords.

Two directions $\{V, W\}$ satisfying the relation $W^t M V = 0$ are called **conjugate directions** of the conic. Two diameters along such two directions are called **conjugate diameters** of the conic.

Parabolas, as we noticed in section 20 are characterized by the condition $AC - B^2 = 0$, have no real center, but have an axis of symmetry parallel to the direction $U^t = (-B, A, 0)$. It is again easily verified that for every direction vector $V^t = (v_1, v_2, 0)$, it is valid the condition

$$U^t M V = 0 .$$

Repeating the procedure in the proof of theorem 4, we come again at equation 16, implying this time, that for chords of the parabola which are parallel to the direction V , their middles are contained on the line $X^t M V = 0$ (variable X), which contains $X = U$. This implies the following property (see figure 17).

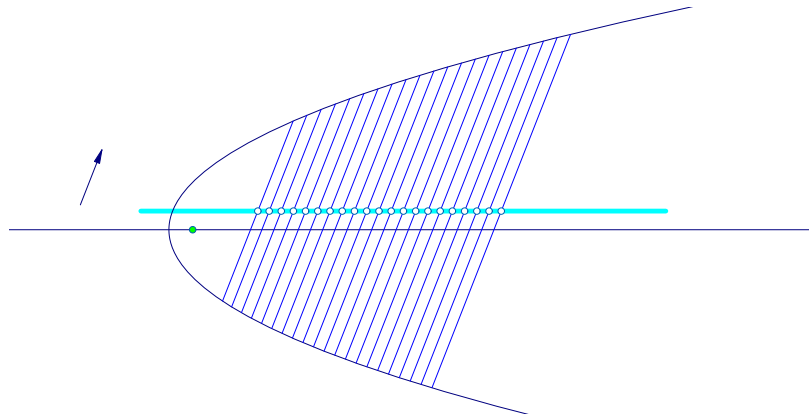

Figure 17: Middles of chords parallel to a given direction V

Theorem 5. *Chords of the parabola which are parallel to a fixed direction, have their middles on a line parallel to the axis of the parabola.*

We could say, that for parabolas the “conjugate” of every direction is the direction of their axis, i.e. the middles of chords parallel to a fixed direction lie on a line parallel to its axis.

Theorem 6. *The tangents at the extremities $\{X, Y\}$ of a chord of the conic intersect at a point Z_0 on the conjugate diameter (line ε') of the chord-direction (see figure 18).*

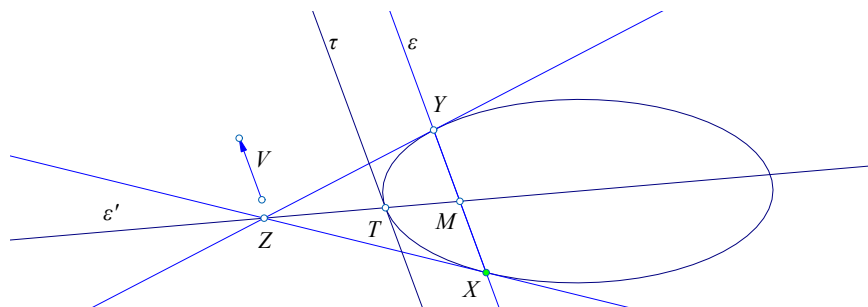

Figure 18: Tangents at chord-ends intersect on conjugate diameter

In fact, with the notation of this section, and $Y = X + sV$, the tangents at $\{X, Y\}$ are the lines

$$Z^tMX = 0 \quad \text{and} \quad Z^tMY = 0 \quad \text{with variable } Z.$$

Their intersection point is determined by the vector product

$$(MX) \times (MY) = (MX) \times (M(X + sV)) = (MX) \times (MX + sMV) = s(MX) \times (MV).$$

And this point is on the line with coefficients the coordinates of MV of the conjugate direction-line, since the mixed product

$$((MX) \times (MY)) \cdot MV = (s(MX) \times (MV)) \cdot MV,$$

later expression being a determinant with two equal columns.

24 Polar and pol

The tangent line of a conic at a point of it is a particular case of a more general line associated to a point with respect to a conic. In fact, given the point X_0 , not necessarily on the conic, equation (13) makes sense and defines a line w.r.t. the variable X , depending on X_0 and the conic. This more general line $p_{X_0}(X) = X_0^tMX = 0$, defined through equation (13), is called the **polar of X_0 with respect to the conic** and X_0 is called the **pol of the line p_{X_0}** .

The polar line is characterized *geometrically* (see figure 19) as the locus of points X for which the **Cross Ratio** $(AB; X_0X) = -1$, i.e. as the locus of the harmonic conjugates X of X_0 with respect to the intersection points $\{A, B\}$ of the conic with a variable line through X_0 . Denoting the line through X_0 by $\gamma(t) = X_0 + tV$, the intersection points are the roots of equation (12). If these roots are $\{t_1, t_2\}$, then the parameter corresponding to the harmonic conjugate point of X_0 is the **harmonic mean** of $\{t_1, t_2\}$ given by $t_3 = 2t_1t_2/(t_1 + t_2)$. By the well known formulas for the product and the sum of the roots of the quadratic equation (12):

$$t_3 = \frac{2t_1t_2}{t_1 + t_2} = -\frac{X_0^tMX_0}{X_0^tMV} \quad \Rightarrow \quad X = X_0 + t_3V = X_0 - \frac{X_0^tMX_0}{X_0^tMV}V.$$

It is then trivially seen that X satisfies the equation of the "polar of" X_0 :

$$X_0^tMX = 0. \tag{17}$$

If the polar p_{X_0} intersects the conic at the points $\{C, D\}$, then the tangents at these points

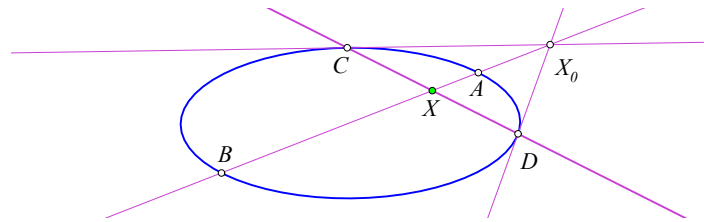

Figure 19: The polar of X_0

pass through X_0 . This is seen by considering the vector X_1 representing such a point. It satisfies two equations: $X_1^tMX_1 = 0$ of the conic, and $X_0^tMX_1 = 0$ of the polar. Hence also the equation of the tangent at X_1 : $X_1^tM(X_1 + t(X_0 - X_1)) = 0$.

Remark 2. Notice that the polar of points X on the conic coincides with the tangent at X . Points X whose polar intersects the conic are **outer** points, i.e. points from which tangents to the conic can be drawn. Points X whose polar does not intersect the conic are **inner** points of the conic, from which no real tangents to the conic exist.

Theorem 7 (Pole Polar Reciprocity). *If point X is on the polar of X_0 then also X_0 is on the polar of X .*

This follows immediately from the symmetry of the expression $XM X_0 = 0$.

25 Quadratic equation classification

Here we recapitulate the results concerning the kind of the related conic.

1. the quadratic: $f(x, y) = Ax^2 + 2Bxy + Cy^2 + 2Dx + 2Ey + F = 0$.
2. the 3 invariants: $J_1 = A + C$, $J_2 = AC - B^2$, $J_3 = \begin{vmatrix} A & B & D \\ B & C & E \\ D & E & F \end{vmatrix}$.
3. degenerate: $J_3 = 0$, and $J_2 = 0 \Rightarrow$ real double line
4. degenerate: $J_3 = 0$, and $J_2 > 0 \Rightarrow$ two complex conjugate lines
5. degenerate: $J_3 = 0$, and $J_2 < 0 \Rightarrow$ two real lines
6. $J_3 \neq 0$ with $A \cdot J_3 > 0$ and $J_2 > 0 \Rightarrow$ complex conic
7. $J_3 \neq 0$ with $A \cdot J_3 < 0$ and $J_2 > 0 \Rightarrow$ ellipse
8. $J_3 \neq 0$ and $J_2 < 0 \Rightarrow$ hyperbola
9. $J_3 \neq 0$ and $J_1 = 0 \Rightarrow$ rectangular hyperbola
10. $J_3 \neq 0$ and $J_2 = 0 \Rightarrow$ parabola $\Rightarrow J_3 \cdot J_1 < 0$

26 Can you easily find a point on the conic?

We take the opportunity of this question to formulate some exercises. To answer the question in the general case it needs to do some work. In special cases it is rather easy. For example, when the linear term is absent and we have an equation of the form

$$Ax^2 + 2Bxy + Cy^2 = 0, \quad (18)$$

which is a special case of degeneration ($J_3 = 0$, $D = E = F = 0$), we have the point $(0, 0)$ on the conic. To find more points in that case, we divide with y and consider the corresponding quadratic equation w.r.t. $t = x/y$:

$$At^2 + 2Bt + C = 0 \quad \text{with discriminant:} \quad -J_2 = B^2 - AC. \quad (19)$$

If $-J_2 > 0$ (case 24.nr-5), then there are two real roots $\{t', t''\}$ and the quadratic decomposes to

$$At^2 + 2Bt + C = A(t - t')(t - t'') = 0 \quad \Leftrightarrow \quad t - t' = 0 \quad \text{or} \quad t - t'' = 0,$$

which setting $t = x/y$ leads to a couple of lines through $(0, 0)$:

$$\beta : x - t' y = 0 \quad \text{and} \quad \beta' : x - t'' y = 0,$$

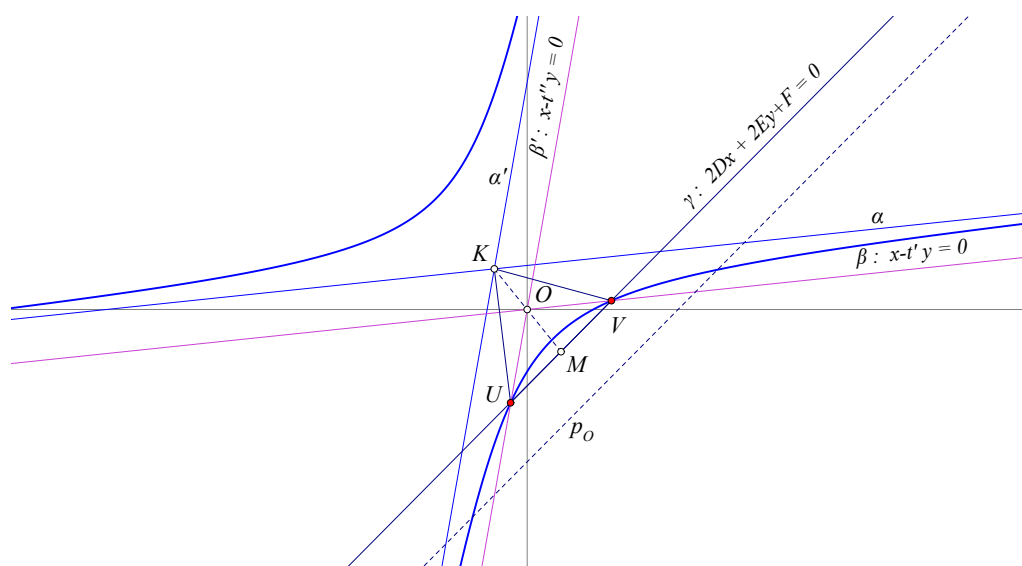

Figure 20: $Ax^2 + 2bxy + Cy^2 = 0$ and $Ax^2 + 2bxy + Cy^2 + 2Dx + 2Ey + F = 0$

their union representing the entire degenerate conic in this case. In figure 20 we see an example of these lines. If to the preceding quadratic part we add the linear part $2Dx + 2Ey + F$ then we get the equation of the general conic

$$Ax^2 + 2Bxy + Cy^2 + 2Dx + 2Ey + F = 0, \quad (20)$$

which under the hypothesis $-J_2 = B^2 - AC > 0$ and the assumption $J_3 \neq 0$ represents a hyperbola (see 25-nr-8).

Exercise 3. Under the hypothesis: $-J_2 = B^2 - AC > 0$ and $J_3 \neq 0$ (the conic is a hyperbola) show that:

1. The intersections $\{U, V\}$ of the lines $\{\beta', \beta\}$ with the line $\gamma : 2Dx + 2Ey + F = 0$ are points of the conic (20).
2. The asymptotes $\{\alpha, \alpha'\}$ of the hyperbola are parallel to the lines $\{\beta, \beta'\}$.
3. The center K of the hyperbola, the origin $O(0, 0)$ and the middle M of the segment UV are collinear.
4. The polar p_O of the origin O w.r.t. to the conic is a line parallel to γ at distance from O twice the distance of O from γ .

The exercise confirms the result of section 19, since changing only the linear part $2Dx + 2Ey + F$ of the equation (20) we obtain hyperbolas with asymptotes parallel to the lines $\{\beta, \beta'\}$ which depend only on the quadratic part of the equation.

In case the discriminant $B^2 - AC = 0$, equation (19) has one double root $t' = -B/A$, the quadratic equation takes the form $A(t - t')^2 = 0$ and equation (18) reduces to the "double line":

$$\alpha^2 : A(x - t'y)^2 = 0 \quad \Leftrightarrow \quad (1/A)(Ax + By)^2 = 0 \quad \text{for } A \neq 0.$$

If we add the linear terms, i.e. the line $\beta : 2Dx + 2Ey + F$, then, assuming $A \neq 0$, equation (20) takes the form

$$(1/A)(Ax + By)^2 + 2Dx + 2Ey + F = 0, \quad (21)$$

and the intersection point P of the lines $\{\alpha, \beta\}$, if any, is a point of the conic. If the lines intersect, then we can find additional points P_t by intersecting the conic with lines $\alpha_t : Ax + By + t = 0$ parallel to α (see figure 21). This leads to a system of two linear equations:

$$\left. \begin{array}{l} Ax + By + t = 0, \\ 2ADx + 2AEy + (AF + t^2) = 0. \end{array} \right\} \Rightarrow \begin{cases} x = \frac{ABF - 2AEt + Bt^2}{2A(AE - BD)}, \\ y = -\frac{AF - 2Dt + t^2}{2(AE - BD)}. \end{cases} \quad (22)$$

giving also a parametrization of the conic, which is a parabola according to 25-nr-10. Notice that, by section 20, line α is parallel to the axis of the parabola. Thus, all parabolas resulting by maintaining the same quadratic term (α^2) and adding different linear terms (β) have their axis in the same direction. Furthermore line β is tangent to the parabola at P . In fact, the coordinates of P are obtained from equations (22) for $t = 0$:

$$x_P = \frac{BF}{2(AE - BD)}, \quad y_P = -\frac{AF}{2(AE - BD)},$$

and the coefficients of the tangent at P are obtained by the matrix multiplication:

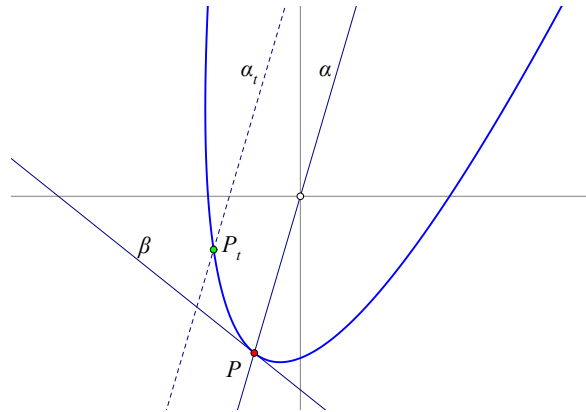

Figure 21: $(Ax + By)^2 + A(2Dx + 2y + F) = 0$

$$(x_P, y_P, 1) \cdot \begin{pmatrix} A^2 & AB & AD \\ AB & B^2 & AE \\ AD & AE & AF \end{pmatrix} = (AD, AE, AF/2),$$

which are half the coefficients of β .

In the case line β does not intersect α , i.e. the two lines are parallel equation (21) takes the form

$$(Ax + By)^2 + A(Ax + By + K) = 0 \quad \text{for some constant } K,$$

and changing the variables as in (8) we get an equation of the form

$$x'^2 + Ax' + AK = 0 \quad \Rightarrow \quad x' = t' \quad \text{or} \quad x' = t'', \quad (t', t'') : \quad \text{the roots of the quadratic.}$$

This shows that the conic degenerates to the couple of parallel lines

$$Ax + By = t'\sqrt{A^2 + B^2} \quad \text{and} \quad Ax + By = t''\sqrt{A^2 + B^2},$$

which can be real, distinct or coinciding or imaginary.

Turning back to equation (19) and assuming the discriminant is $-J_2 = B^2 - AC < 0$, we get two complex conjugate roots $\{u \pm i \cdot v\}$ and the quadratic equation can be written in the form:

$$At^2 + 2Bt + C = A(t^2 - 2ut + u^2 + v^2) = 0.$$

Adding the linear part, replacing t with x/y and assuming the conic is non degenerate, equivalently $J_3 \neq 0$, we obtain, according to 25-nr-7, an ellipse represented by

$$x^2 - 2uxy + (u^2 + v^2)y^2 + 2(D/A)x + 2(E/A)y + F/A = 0.$$

Figure 22 shows the special ellipse λ for which $D = E = 0$, $k = F/A < 0$ and λ' a real

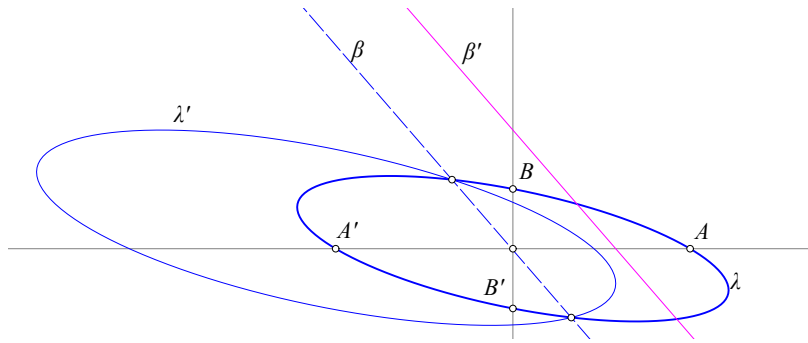

Figure 22: Ellipse: $x^2 - 2uxy + (u^2 + v^2)y^2 + 2(D/A)x + 2(E/A)y + F/A = 0$

ellipse for $F/A = k$ and arbitrary coefficients $\{D, E\}$, line β represented by $Dx + Ey = 0$ and line β' represented by $2(D/A)x + 2(E/A)y + k = 0$ and being parallel to β . The ellipses $\{\lambda', \lambda\}$ intersect on line β and the intersection points can be found by solving a quadratic equation. Notice again, that the directions of the axes is the same for the two ellipses, since these directions depend on the common quadratic part of their equations.

27 On the focal points

Suppose the quadratic equation with $J_2 = AC - B^2 \neq 0$, representing a central conic, is expressed with its center at the origin of coordinates:

$$Ax^2 + 2Bxy + Cy^2 + F = 0.$$

Then, the general transformation of the coordinates as in section 3, is equivalent with a matrix multiplication, and if this produces the normal form, then we have a diagonal matrix:

$$\begin{aligned} \begin{pmatrix} c & s \\ -s & c \end{pmatrix} \begin{pmatrix} A & B \\ B & C \end{pmatrix} \begin{pmatrix} c & -s \\ s & c \end{pmatrix} &= \begin{pmatrix} A' & 0 \\ 0 & B' \end{pmatrix} \Leftrightarrow \\ \begin{pmatrix} A & B \\ B & C \end{pmatrix} \begin{pmatrix} c & -s \\ s & c \end{pmatrix} &= \begin{pmatrix} c & -s \\ s & c \end{pmatrix} \begin{pmatrix} A' & 0 \\ 0 & B' \end{pmatrix} \Leftrightarrow \\ \begin{pmatrix} A & B \\ B & C \end{pmatrix} \begin{pmatrix} c \\ s \end{pmatrix} &= A' \begin{pmatrix} c \\ s \end{pmatrix} \quad \text{and} \quad \begin{pmatrix} A & B \\ B & C \end{pmatrix} \begin{pmatrix} -s \\ c \end{pmatrix} = B' \begin{pmatrix} -s \\ c \end{pmatrix}. \end{aligned}$$

This shows that the coefficients $\{A', B'\}$ in the normal form

$$A'x'^2 + B'y'^2 + F = 0 \tag{23}$$

are the **eigenvalues** of the matrix $M = \begin{pmatrix} A & B \\ B & C \end{pmatrix}$ and the axes of the conic are determined by the **eigenvectors** of M . The equation for the eigenvalues is expressed through the determinant

$$\begin{vmatrix} A - \lambda & B \\ B & C - \lambda \end{vmatrix} = 0 \quad \Leftrightarrow \quad \lambda^2 - (A + C)\lambda + B^2 - AC = 0 \quad \Leftrightarrow \quad \lambda^2 - J_1\lambda + J_2 = 0,$$

which is equation (5) now obtaining a meaning in from the linear algebra viewpoint. If we know the signs of the coefficients $\{A', B, F\}$ we can use this method to locate the focal points of the conic expressed through this equation. In fact equation (23) can be written

$$\frac{x'^2}{\left(\frac{F}{A'}\right)} + \frac{y'^2}{\left(\frac{F}{B'}\right)} + 1 = 0. \quad (24)$$

If both denominators are negative, then this represents an ellipse, which dropping the primes from the variables is expressed through

$$\frac{x^2}{a_0^2} + \frac{y^2}{b_0^2} = 1 \quad \text{with} \quad a_0^2 = -\frac{F}{A'}, \quad b_0^2 = -\frac{F}{B'}.$$

Assuming $a_0 > b_0$, the distance of the focus from the origin is

$$c_0 = \sqrt{a_0^2 - b_0^2} = \sqrt{\frac{F}{A'B'}(A' - B')} = \sqrt{\frac{F}{J_2}(A' - B')} \quad \text{and the focals are} \quad \pm c_0 \begin{pmatrix} c \\ s \end{pmatrix}.$$

If $\frac{F}{A'} < 0$ and $\frac{F}{B'} > 0$ then equation (24) can be written

$$\frac{x^2}{a_0^2} - \frac{y^2}{b_0^2} = 1 \quad \text{with} \quad a_0^2 = -\frac{F}{A'}, \quad b_0^2 = \frac{F}{B'}.$$

Again the distance of the focus from the origin is

$$c_0 = \sqrt{a_0^2 + b_0^2} = \sqrt{\frac{F}{J_2}(A' - B')} \quad \text{and the focals are} \quad \pm c_0 \begin{pmatrix} c \\ s \end{pmatrix}.$$

Related topics

1. [Cross Ratio](#)
2. [Projective line](#)
3. [Projective plane](#)